

# Embedding Online Test & Monitoring Features in Real Time Hardware Systems

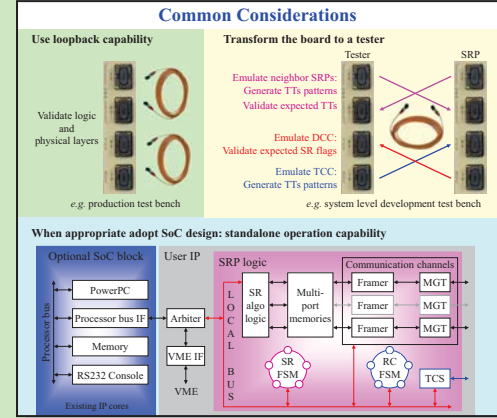

## Context

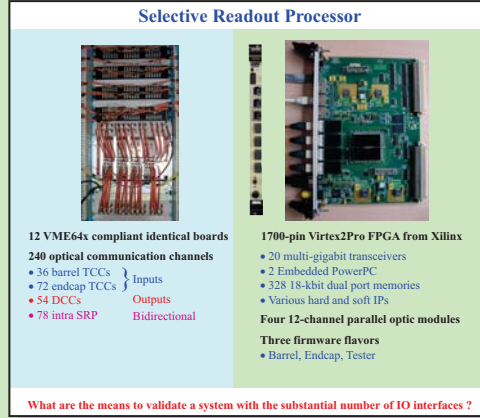
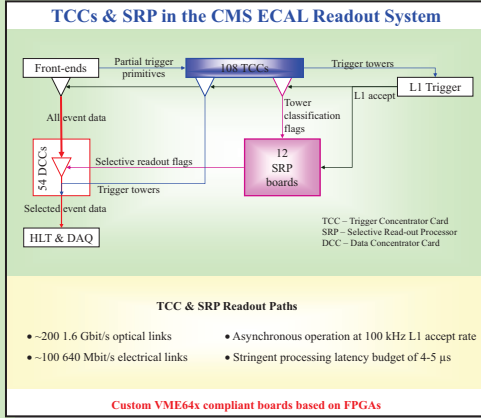

## Principles & Applications

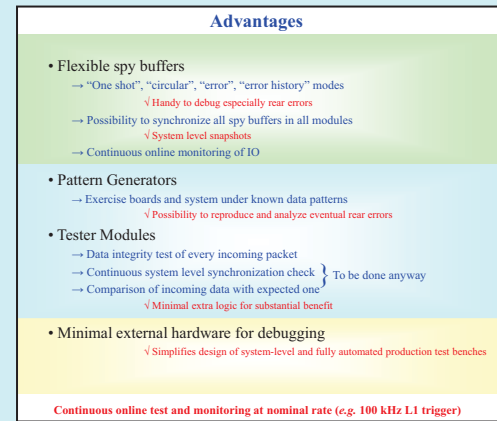
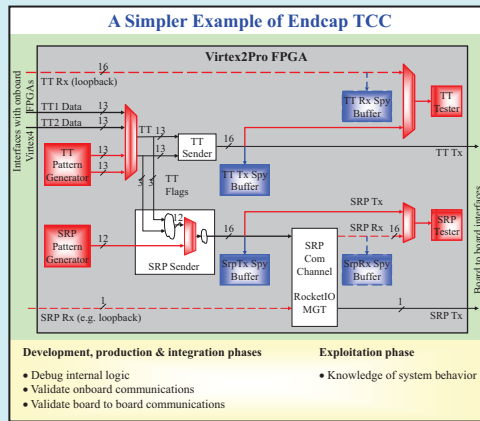
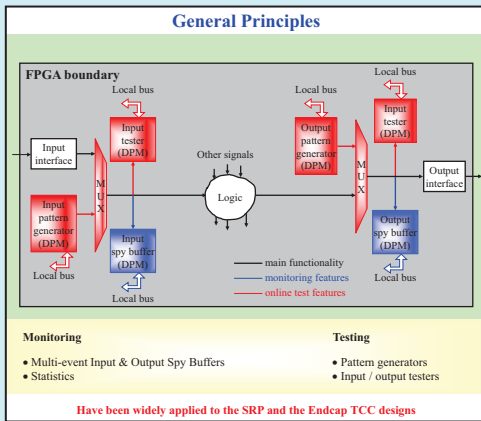

## Remote Firmware Management

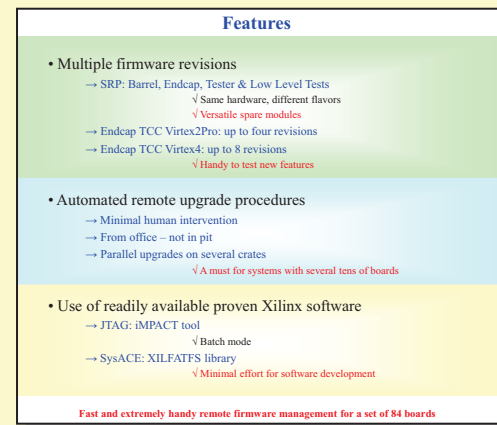
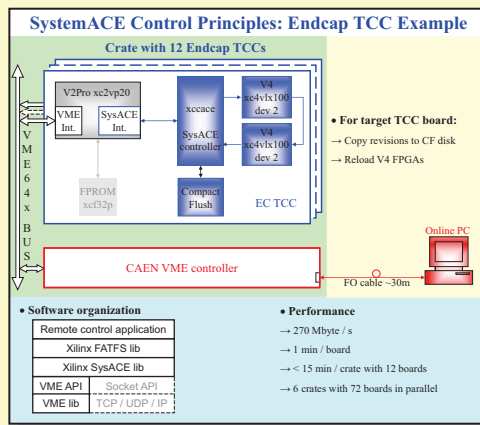
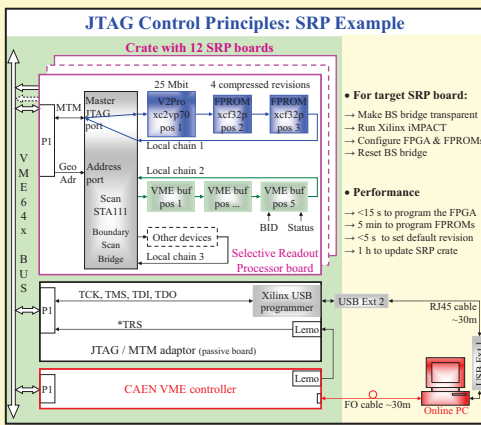

Online test and monitoring logic, that closely couples with functional features, and remote firmware control greatly simplify development, production, commissioning and maintenance of large scale FPGA-based real time systems